

AlGaInP Visible Laser Diode

ADL-63202TL

6-2D-LD63-070_Rev.01

★635nm 20mW 50°C Reliable Operation

• Features

1. High visibility
2. Small perpendicular divergence angle

• Applications

1. Industrial laser markers
2. Survey and engineering instruments
3. High visibility LD display

• Absolute maximum ratings

Parameter	Symbol	Condition	Rating	Unit
Light output power	P_O	CW	30	mW
Reverse voltage (LD)	V_{RL}	-	2	V
Reverse voltage (PD)	V_{RD}	-	30	V
Forward current (PD)	I_{FD}	-	10	mA
Case temperature	T_C	-	-10~+50	°C
Storage temperature	T_S	-	-40~+85	°C

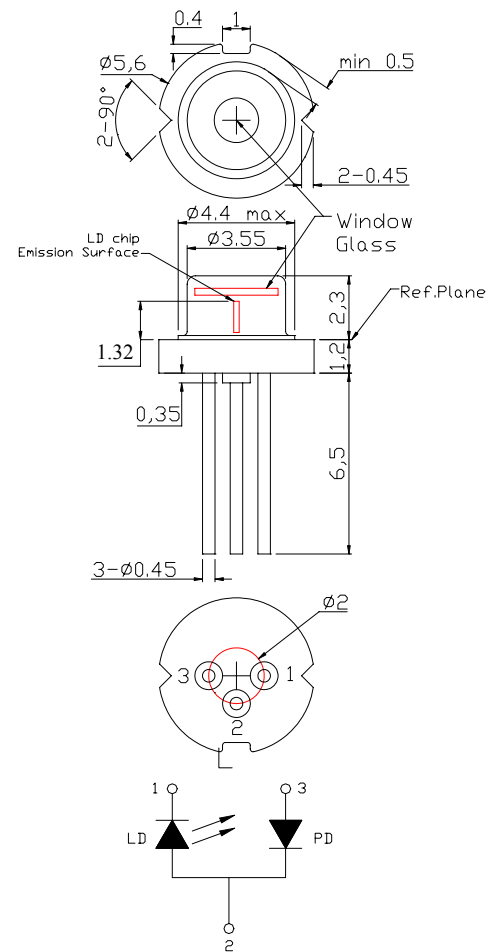

• Electrical and optical characteristics ($T_c=25^\circ\text{C}$)

Parameter	Symbol	Min.	Typ.	Max.	Unit	Conditions
Peak wavelength	λ	630	640	645	nm	$P_o=20\text{mW}$
Threshold current	I_{th}	-	40	50	mA	
Operating current	I_{op}	-	70	80	mA	$P_o=20\text{mW}$
Operating voltage	V_{op}	-	2.3	2.7	V	$P_o=20\text{mW}$
Differential efficiency	η	0.4	0.6	0.80	mW/mA	$P_o=10\text{-}20\text{mW}$
Monitor current	I_m	0.05	0.15	0.5	mA	$P_o=20\text{mW}$, $V_{RD}=5\text{V}$
Parallel divergence angle	$\theta_{ }$	6	8	11	deg	$P_o=20\text{mW}$
Perpendicular divergence angle	θ_{\perp}	25	30	35	deg	
Parallel FFP deviation angle	$\Delta\theta_{ }$	-3	0	+3	deg	
Perpendicular FFP deviation angle	$\Delta\theta_{\perp}$	-3	0	+3	deg	
Emission point accuracy	$\Delta x \Delta y \Delta z$	-80	0	+80	um	

• Precautions

- * Do not operate the device above maximum ratings. Doing so may cause unexpected and permanent damage to the device.
- * Take precautions to avoid electrostatic discharge and/or momentary power spikes. A change in the characteristics of the laser or premature failure may result.
- * Proper heat sinking of the device assures stability and lifetime. Always ensure that maximum operating temperatures are not exceeded.
- * Observing visible or invisible laser beams with the human eye directly, or indirectly, can cause permanent damage. Use a camera to observe the laser.
- * No laser device should be used in any application or situation where life or property is at risk in event of device failure.
- * Specifications are subject to change without notice. Ensure that you have the latest specification by contacting us prior to purchase or use of the product.

* For reference only. Contents above are subject to change without notice.

Arima
LASERS

AlGaInP Visible Laser Diode

ADL-63202TL

6-2D-LD63-070_Rev.01

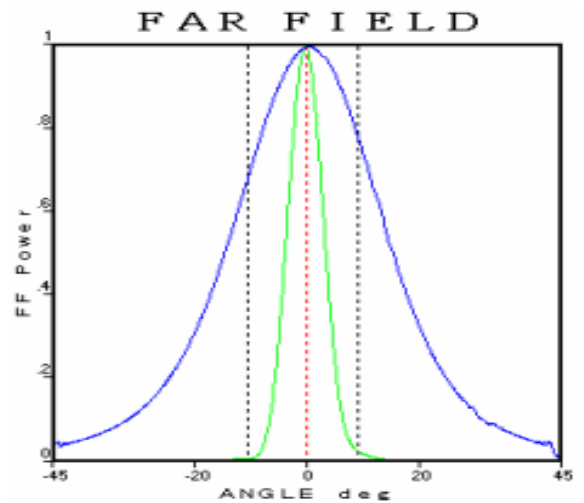
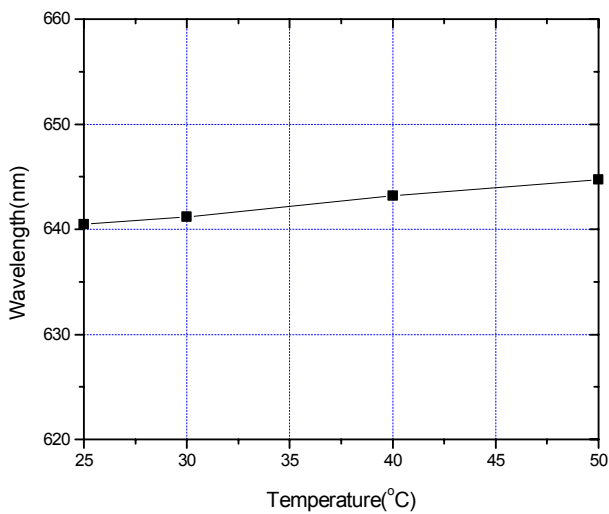
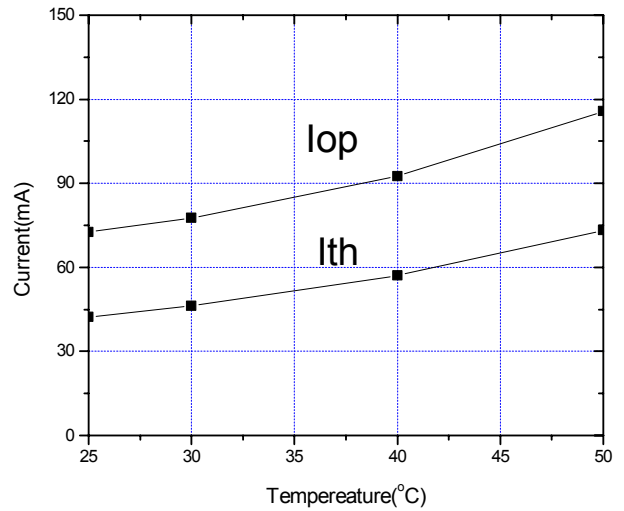
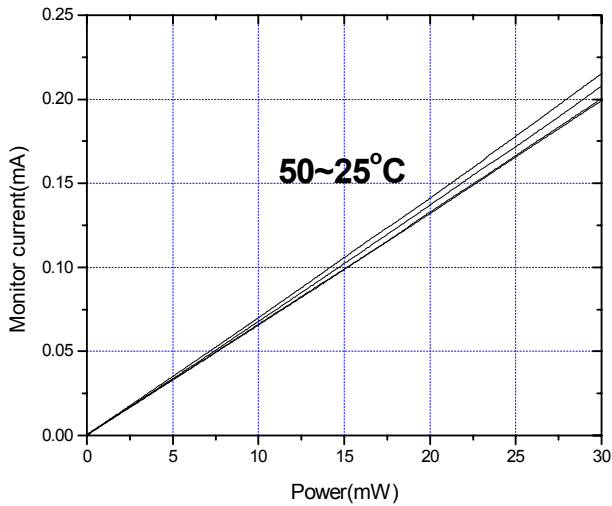
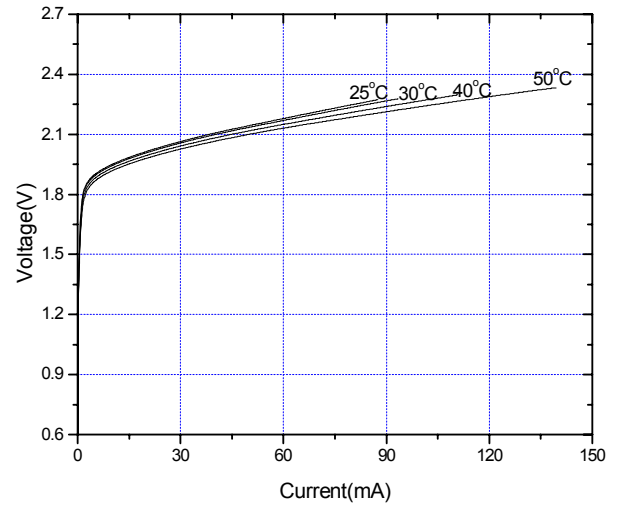
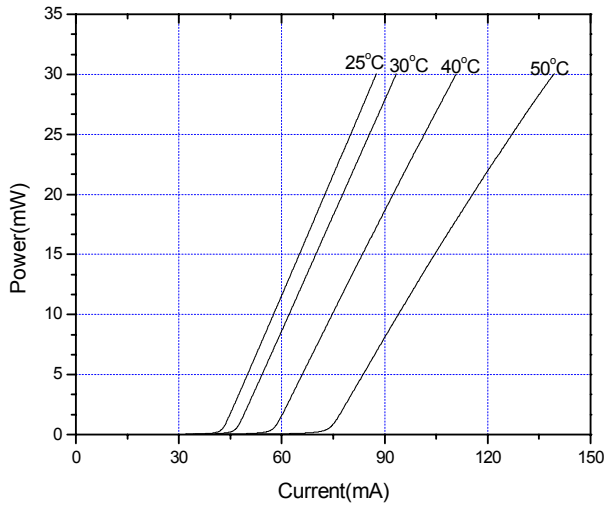

* For reference only. Contents above are subject to change without notice.